

DESTEKLER

SUPPORTS

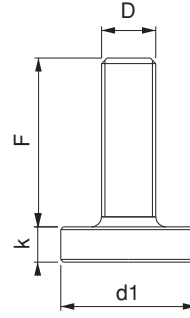

Referans Nr.	D x F	d1	k	
1490-08032	M8x32	25	8	40
1490-10042	M10x42	30	8	60
1490-12050	M12x50	36	10	110
1490-12095	M12x95	36	10	150
1490-16062	M16x62	45	13	240
1490-16097	M16x97	45	13	285
1490-16117	M16x117	45	13	310
1490-20062	M20x62	50	13	320
1490-20097	M20x97	50	13	390
1490-20117	M20x117	50	13	430
1490-24081	M24x81	50	14	445
1490-24116	M24x116	50	14	555
1490-30180	M30x180	70	24	1650







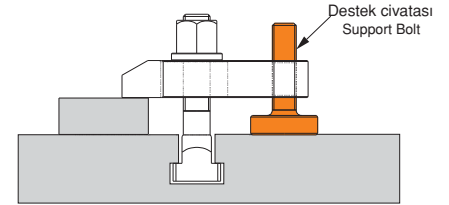

Ürün Nr. 1490 Pabuç Destek Civatası

- Siyah Kaplama

Product Nr. 1490 Clamp Support Bolt

- Black Coating



Referans Nr.		d				
1510-023030	23-30	M16	34	32	1000	140
1510-040060	40-60	M16	34	32	1800	250
1510-042052	42-52	Tr 30x4	50	50	6000	570
1510-050070	50-70	Tr 30x4	50	50	6000	680
1510-070100	70-100	Tr 30x4	50	50	6000	960
1510-100140	100-140	Tr 30x4	50	50	6000	1395
1510-140220	140-220	Tr 30x4	54	54	6000	2285
1510-210330	210-330	Tr 30x6	58	58	8000	3950
1510-260430	260-430	Tr 30x6	68	68	8000	7250

Trapez Diş Yükseltici Destek

Trapeze Thread Lifter Support

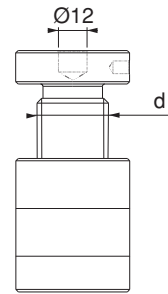

Ürün Nr. 1510 Trapez Diş Yükseltici Destek

- Nr. 1510 yükselticiler DIN 6314-6315-6316 pabuçlarda yükseltici destek amaçlı kullanılır.
- Hareketli parça üstünde bulunan Ø12mm delik Referans Nr. 1555-1560-1565-1570-1575 yükselticiler üst üste ve farklı amaçlı kullanılır
- Siyah Kaplama
- Destek Civatası : Sertleştirilmiş

Product Nr. 1510 Trapeze Thread Lifter Support

- Nr.1510 Lifters are used in DIN 6314-6315-6316 clamps as the lifter support
- Hole with Ø12mm taking place on the moving part are used with the lifters with the Reference Nr.1 555-1560-1565-1570-1575 on top of each other and also used with different purpose.
- Black Coating
- Support Bolt : Hardened



Referans Nr.	H min.	H max.	D1	Ø12x50 H1 min.- H1 max.	Ø12x80 H1 min.- H1 max.	↓ Kgf	↑ (g)
1515-065085	65	85	50	93-113	123-143	3000	810
1515-085125	85	125	50	113-153	143-183	3000	1050

Ürün Nr. 1515 Manyetik Vidalı Yükseltici

- Ürün manyetik olduğundan dolayı kendi ağırlığını taşıdığı için yatay bağlamalarda özellikle enjeksiyon makinelerinde kullanım avantajı sağlar.
- Sertleştirilmiş
- Siyah kaplama

Product Nr. 1515 Magnetic Screw Booster

- Because of magnetic it holds its own weight. Therefore it provides using advantage in horizontal clamping especially on injection machines.
- Hardened
- Black coating

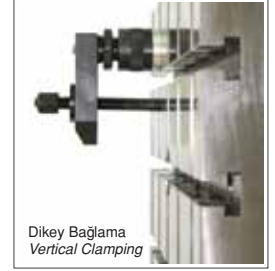
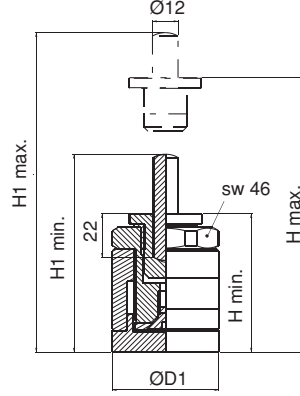

Modüler Manyetik Yükseltici

Referans Nr.	H min-max. A	H min-max. B	TR	d1	d2	d3	↓ kgf	↑ (g)
1517-04262	42-52	52-62	30x4	50	50	53.5	6000	700
1517-05080	50-70	60-80	30x4	50	50	53.5	6000	770
1517-70110	70-100	80-110	30x4	50	50	53.5	6000	1050

Ürün Nr. 1517 Modüler Manyetik Yükseltici

- Siyah Kaplama

Product Nr. 1517 Modüler Magnetic Booster

- Black coating

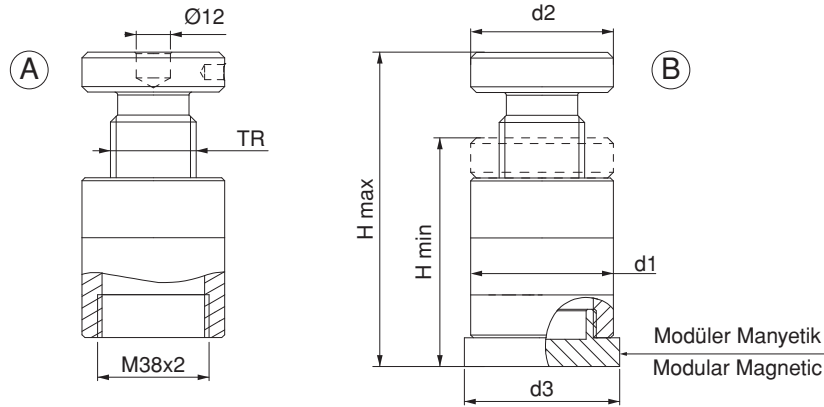

Referans Nr.	H min.	H max.	b1	b2	L	sw	↑ kgf	↑ (g)
1520-050063	50	63	-	40	63	8	4000	1890
1520-100125	100	125	115	60	125	14	10000	9910
1520-170190	170	190	145	80	175	22	25000	28480

Ürün Nr. 1520 Blok Destek

- Ürün Özellikle ağır parçaların desteklenmesi ve kaldırılması için tasarlanmıştır.
- Sertleştirilmiş
- Siyah kaplama

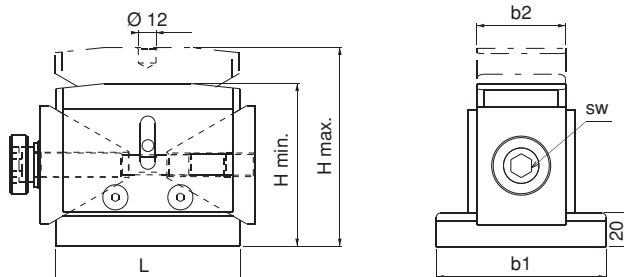

Product Nr. 1520 Support Block

- Designed for supporting and lifting of heavy work pieces
- Hardened
- Black coating



Blok Destek Support Block



Referans Nr.		d	g	k	 kgf	 (kg)
1530-200	200-300	Tr40x7	69	28	8000	10.0
1530-280	280-460	Tr40x7	69	28	6000	11.8
1530-430	430-750	Tr40x7	69	28	5000	14.2
1530-710	710-1250	Tr40x7	69	28	4000	20.9



Ürün Nr. 1530 Büyük Boy Yükseltici Destek

- Yüksek parçalarda kullanım amaçlı trapez diş yükseltici destek
- Gövde statik boyalı. Altı köşede bulunan Ø12mm delik
- Referans Nr. 1555-1560-1565-1570-1575 ürünlerle kullanıldığında farklı kullanım avantajı sağlar.

Product Nr. 1530 King Size Lifter Support

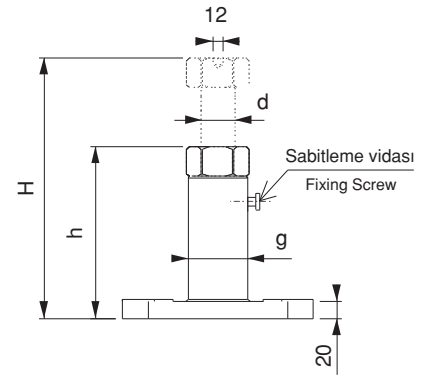
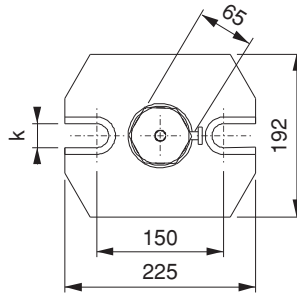
- This is a trapeze thread lifting support having the purpose of using with High Pieces.
- Body and statical painting. It provides different usage advantages when Ø12mm hole is used with 1555-1560-1565-1570-1575 reference numbered products taking place.



Referans Nr.		d	g	k	 kgf	 (kg)
1550-100	100-140	Tr30x6	49	18	6000	2.05
1550-140	140-200	Tr30x6	49	18	6000	2.45
1550-200	200-320	Tr30x6	49	22	4000	3.90
1550-320	320-550	Tr30x6	49	22	2500	5.15

Ürün Nr. 1550 Büyük Boy Yükseltici Destek

- Yüksek parçalarda kullanım amaçlı trapez diş yükseltici destek
- Gövde statik boyalı. Altı köşede bulunan Ø12mm delik
- Referans Nr. 1555-1560-1565-1570-1575 ürünlerle kullanıldığında farklı kullanım avantajı sağlar.

Product Nr. 1530 King Size Lifter Support

- This is a trapeze thread lifting support having the purpose of using with High Pieces.
- Body and statical painting. It provides different usage advantages when Ø12mm hole is used with 1555-1560-1565-1570-1575 reference numbered products taking place.

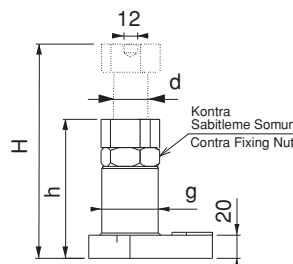
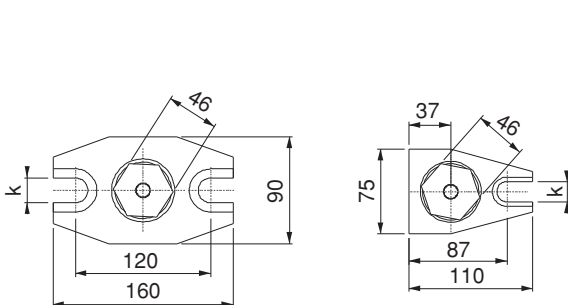

Trapez Diş Yükseltici Destek

Trapeze Thread Lifter Support



Referans Nr.	h	Ø d	
1555	10	37	75

Bu ürünler Nr. 1510-1517-1530-1550 ürünler ile kullanılır

These products are used with the product Nos 1510-1517-1530-1550 taking place.

Radüslü Destek Rad-top Support



Ürün Nr. 1555 Trapez Diş Yükseltici Radüslü Destek

- Açılı yüzeylerde kullanım kolaylığı sağlar
- Siyah Kaplama

Product Nr. 1555 Trapeze Thread Lifter Rad-top Support

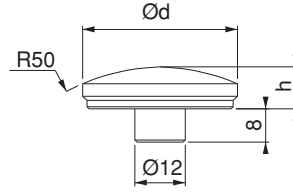
- This part provides usage convenience on angled surfaces
- Black Coating



Referans Nr.	h	Ø d		Kgf	
1560	25	45	3000	220	

Ürün Nr. 1560 Trapez Diş Yükseltici Bilyalı Destek

- Bozuk yüzeylerde kullanım kolaylığı sağlar
- Siyah Kaplama

Product Nr. 1560 Trapeze Thread Lifter Ball Support

- This part provides usage convenience on irregular surfaces
- Black Coating

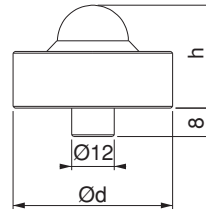

Bilyalı Destek Ball Support

Referans Nr.	h	Ø d	Ø d1		
			min	max	
1565	15	45	10	50	130

Ürün Nr. 1565 Trapez Diş Yükseltici V-Yatak

- Silindirik parçalarda V yatak desteği
- Siyah Kaplama

Product Nr. 1565 Trapeze Thread Lifter V-Clamping Block

- V clamping block support for cylindrical pieces
- Black Coating

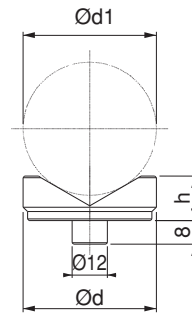

V-Yatak V-Clamping Block



Referans Nr.	h	Ø d	Ø d1	L	
1570	12	50	15	20	220

Ürün Nr. 1570 Trapez Diş Yükseltici Pimli Destek

- Şekilli parçalarda araya giderek destek sağlar
- Siyah Kaplama

Product Nr. 1570 Trapeze Thread Lifter Pin Support

- This part provides support for formed pieces by entering in between
- Black Coating

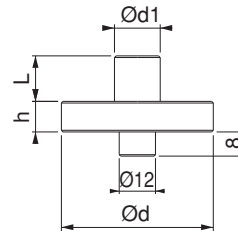

Pimli Destek Pin Support



Referans Nr.	h	Ø d	Ø d1	Ø d2	
1575	8	45	35.8	30	105

Ürün Nr. 1575 TDY Ara Merkezleme Vasatı

- Trapez diş yükselticiler üst üste kullanıldığında ara merkezleme vasatı olarak kullanılır
- Siyah Kaplama

Product Nr. 1575 TDY Intermediary Centering Mean

- This part is used as Intermediary Centering Mean when used with Trapeze Thread Lifters
- Black Coating

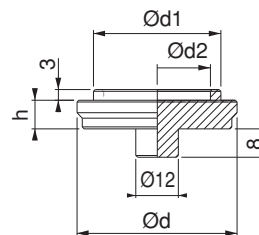

Ara Merkezleme Vasatı Intermediary Centering Mean



Referans Nr.	h	a	c	k	b	L	b1	b2	
1580-050	13	8	13	37	52	50	52	78	460
1580-060	16	10	17	47	64	60	64	96	860
1580-070	19	13	18	57	76	70	76	114	1420

Ürün Nr. 1580 Basamaklı Destek

- Siyah Kaplama

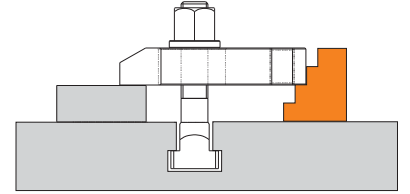
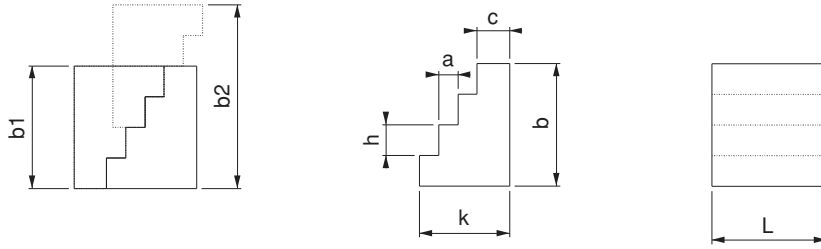

Product Nr. 1580 Stepped Support

- Black Coating



Merdiven Diş Kombine Destek

Serrated Thread Combined Support

Referans Nr.	h-H	e	 kgf	
1585-050	110-150	48x48	4000	1120
1585-060	155-220	60x58	5000	2710
1585-080	220-340	80x78	6000	6560

Ürün Nr. 1585 Merdiven Diş Kombine Destek

- Yükseltme aralığı (hatve) 3mm'dir
- Siyah Kaplama

Product Nr. 1585 Serrated Thread Combined Support

- Lifting gap (screw pitch) is 3 millimeters
- Black Coating

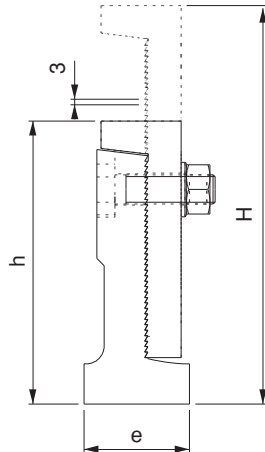

Referans Nr.	h	s	M1	d1	d	M	L	w	h1	L1	M2	İzin Verilen Vida Torku Allowable Screw Torque(Nm)	Destek Kapasitesi Support Capacity (kgf)	Piston Yay Kuvveti Piston Spring Force (N)	 (g)
1588-060	33	6	M6x12	14	28	M6	10	4	22	14.1	M6x16	7.5	400	10~22	150
1588-080	42	10	M8x16	19	35	M8	15	5	28.5	18.8	M8x20	14	600	10~27	300
1588-100	50	10	M10x20	22	42	M10	14	6	34	23.8	M10x25	18	750	14~28	540
1588-120	60	10	M12x24	26	50	M12	17	8	42	28.5	M12x30	22	900	15~30	865
1588-160	70	10	M16x32	33	60	M16	22	10	47	26.5	M12x30	25	900	15~35	1.390

Ürün Nr. 1588 Ayarlı Destek
• Siyah kaplama

Product Nr. 1588 Adjustable Support
• Black coating

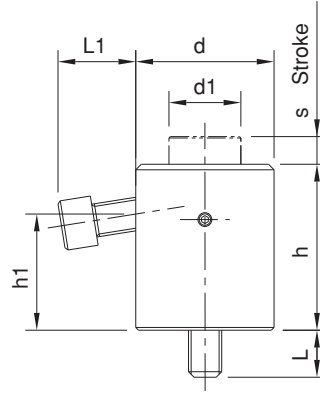
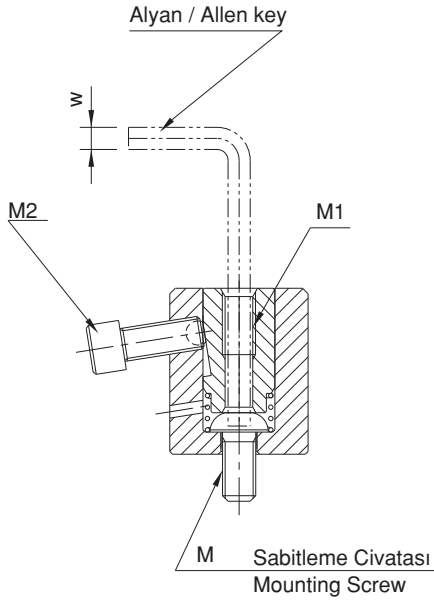

Uygulama Örneği / Application Example

